

Revision Notes.				
R1 - RADIUS INCORRECTLY DIMENSIONED ON SUNSHIELD CORRECTED.				
APA: WENFENG QIN	Drawn: M.BUTLER	Checked: R.BATES	Approved: B.JOHN	Date: 03/04/14

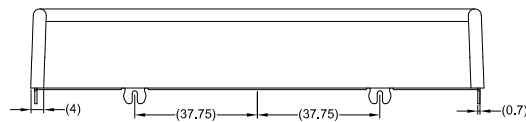
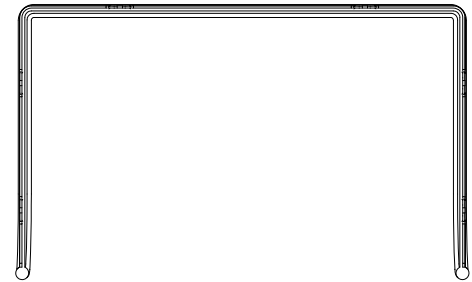
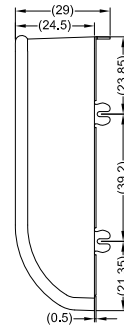
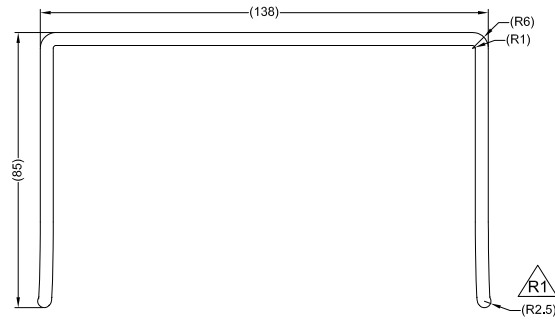
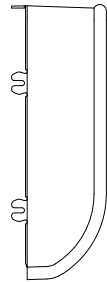
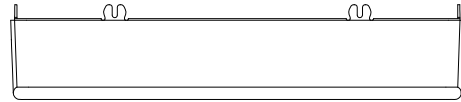
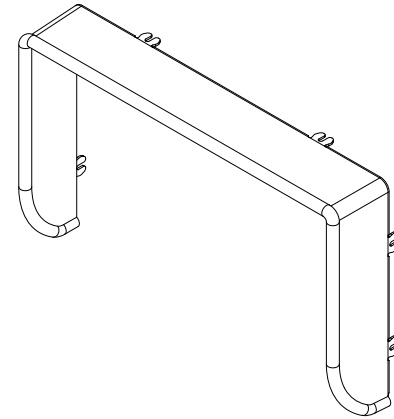

NOTES:  
 1. FINISH: TEXTURED, MATT BLACK.  
 2. MATERIAL: ABS-757.

**PROPRIETARY NOTICE**  
 THIS DESIGN AND TECHNICAL INFORMATION APPEARING ON THIS DRAWING IS THE PROPERTY OF BRIGADE ELECTRONICS, AND IS DISCLOSED IN CONFIDENCE. IT IS NOT TO BE COPIED, REPRODUCED, REVEALED TO OR EXPROPRIATED BY OTHERS, EITHER IN WHOLE OR IN PART WITHOUT THE EXPRESS WRITTEN CONSENT OF BRIGADE ELECTRONICS.

**BRIGADE**<sup>®</sup>  
 www.brigade-electronics.com

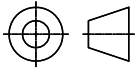
Assembly Pl Approval DONGQING LIN (20/01/14)	Approved by B.JOHN	Checked by R.BATES	Drawn by M.BUTLER
Angle of Projection	Units mm	Scale N/A	Released 20/01/14
 Third Angle	Status RELEASED	Assembly Ref VBV-770M-SS	
	Part No 4523	BE-002625-01-13	